

Electrolux

WASHER DRYER WD1039



User's Handbook



Important User Information

IT IS MOST IMPORTANT THAT THIS INSTRUCTION BOOK SHOULD BE RETAINED WITH THE APPLIANCE FOR FUTURE REFERENCE. SHOULD THE APPLIANCE BE SOLD OR TRANSFERRED TO ANOTHER OWNER, OR SHOULD YOU MOVE HOUSE AND LEAVE THE APPLIANCE, ALWAYS ENSURE THAT THE BOOK IS SUPPLIED WITH THE APPLIANCE IN ORDER THAT THE NEW OWNER CAN BE ACQUAINTED WITH THE FUNCTIONING OF THE APPLIANCE AND THE RELEVANT WARNINGS.

PLEASE ENSURE THAT YOU HAVE READ THE WHOLE INSTRUCTION BOOK BEFORE USING THE APPLIANCE AND THAT YOU FOLLOW THE RECOMMENDATIONS GIVEN.

THESE WARNINGS ARE PROVIDED IN THE INTEREST OF SAFETY. YOU MUST READ THEM CAREFULLY BEFORE INSTALLING OR USING THE APPLIANCE.

- This appliance is designed to be operated by adults. Children should not be allowed to tamper with the controls or play with the product.
- It is dangerous to alter the specifications or attempt to modify this product in any way.
- Any electrical work required to install this appliance should be carried out by a qualified electrician.
- Any plumbing work required to install this appliance should be carried out by a qualified plumber.
- This product should be serviced by an authorised Electrolux Service Centre, and only genuine Electrolux spare parts must be used.
- Care must be taken to ensure that the appliance does not stand on the electrical supply cable.
- Always unplug the appliance and turn off the water after use.
- This appliance is heavy. Care should be taken when moving it.
- All packing and transit bolts must be removed before use. Serious damage can occur to the product and to property if this is not adhered to. See relevant section in instructions.
- Do not overload the appliance. See relevant section in instruction book.
- Only wash fabrics which are designed to be machine washed. If in doubt, consult the manufacturer of that item.
- Before washing, ensure that all pockets are empty and buttons and zips are fastened. Avoid washing frayed or torn articles and treat stains such as paint, ink, rust and grass. Underwired bras must not be machine washed.
- Any objects such as coins, safety pins, nails, screws, stones or any other hard, sharp material can cause extensive damage and must not be placed into appliance.
- Garments which are saturated with petroleum products should not be machine washed. If volatile cleaning fluids are used, care should be taken to ensure that the fluid is removed from the garment before placing in the machine.
- Wash small items such as socks, laces, washable belts etc in a washing bag or pillow case as it is possible for such items to slip down between the tub and the inner drum.
- Only use the advised quantities of fabric softener. Damage to the fabric can ensue if you over-fill. Refer to the manufacturers' recommendations of quantities.
- Pets have been known to climb into washing machines. Please check your drum before use.
- Under no circumstances should you attempt to repair the machine yourself. Repairs carried out by inexperienced persons may cause injury or more serious malfunctioning. Contact your local Electrolux Centre. Always insist on genuine Electrolux spare parts.
- This machine should not be used for any purpose other than the washing of machine washable fabrics in a solution of water and a low suds detergent.
- This appliance should be connected and installed by a professional plumber. Do not connect to a mixer tap, or water heater.
- Always ensure that the water taps are switched on to the machine before starting a wash.
- There is no water draining after the last rinse for the gentle wash cycles. Always ensure that dial is turned to I to drain and spin or turn to U to drain without spinning. Do not open the door until one of the drain programmes has been completed. If you do there will be a flood.
- Use a low lather powder.
- Close the dispenser drawer gently before switching the machine on. Do not open the dispenser drawer whilst the machine is in operation.
- Do not remove the filter for cleaning when the machine is in operation.
- If a stacking kit is used the instructions should be followed closely.
- No attempt should be made to remove the panels except to fit a stacking kit.

- The connector at the free end of the inlet hose should not be removed or replaced with an alternative connector.
- The inlet hose should not be cut in order to change the length.
- When disposing of your washing machine please remove the door to avoid an accident to children or animals being trapped.
- Only tumble dry fabrics which are designed to be tumble dried. If in doubt, consult the manufacturer of that item.
- Never tumble dry items that have had contact with chemicals such as dry cleaning fluid. These are of a volatile nature and could cause an explosion. Only tumble dry items which have been washed in water or require airing.
- Before the drying cycle always remove re-usable plastic detergent dispensers designed to be placed inside the drum with the clothes as the plastic used is not designed to withstand the heat of the drying cycle.

Contents

Page		Page	
3	Specifications.	16	Drying.
4	About your Washer Dryer.	17	Looking after your Machine.
6	Electrical Information.	18-19	Helpful tips.
7-8	The Controls and how to use them.	20	Servicing.
9-12	The Programmes.	22	Guarantee.
13-15	Using your Machine.		

Specifications

Dimensions

Height	850mm 33.5"
Width	600mm 23.6"
Depth	600mm 23.6"
Weight	90kg 198lb
Capacity for wash	4.5kg 10lb
Capacity for drying	2.25kg 5lb
Revolutions per minute	500/1000
Total power	2500W
Heater rating (wash)	2300W
Heater rating (drying)	1350W

Motor rating

Wash	200W
Spin	400/550W
Voltage	220/240V
Frequency	50Hz

Water load

Normal	13 litres 2.9 gallons
High	20 litres 4.4 gallons

Pressure psi

Maximum	110
Minimum (hot)	4
Minimum (cold)	7

About your washer dryer

Your new Electrolux washer dryer has a selection of programmes to suit all your washing and drying needs.

This booklet not only tells you how to operate your new washer dryer, but also contains a number of helpful tips on how to get the best results. **SO PLEASE READ IT THROUGH CAREFULLY BEFORE USING THE MACHINE.**

It also includes an important checklist of what to do should a fault occur, plus a list of the Electrolux service offices where service can be obtained if it is needed.

Before requesting service please check whether your problem is covered on page 20 under "Servicing" and that you are operating the machine according to the instructions. If the engineer finds that the problem is due to misuse or incorrect installation you may be charged for his visit, even though your machine is under guarantee.

- ① Programme Selector Dial and On/Off Control
- ② Drying Time Control
- ③ Door Release Button
- ④ Half Load/Autodry Facility Button
- ⑤ Delicate Dry Button
- ⑥ Detergent Dispenser
- ⑦ Programme Guide
- ⑧ Delay Start Timer
- ⑨ Pump Filter (behind lower panel)

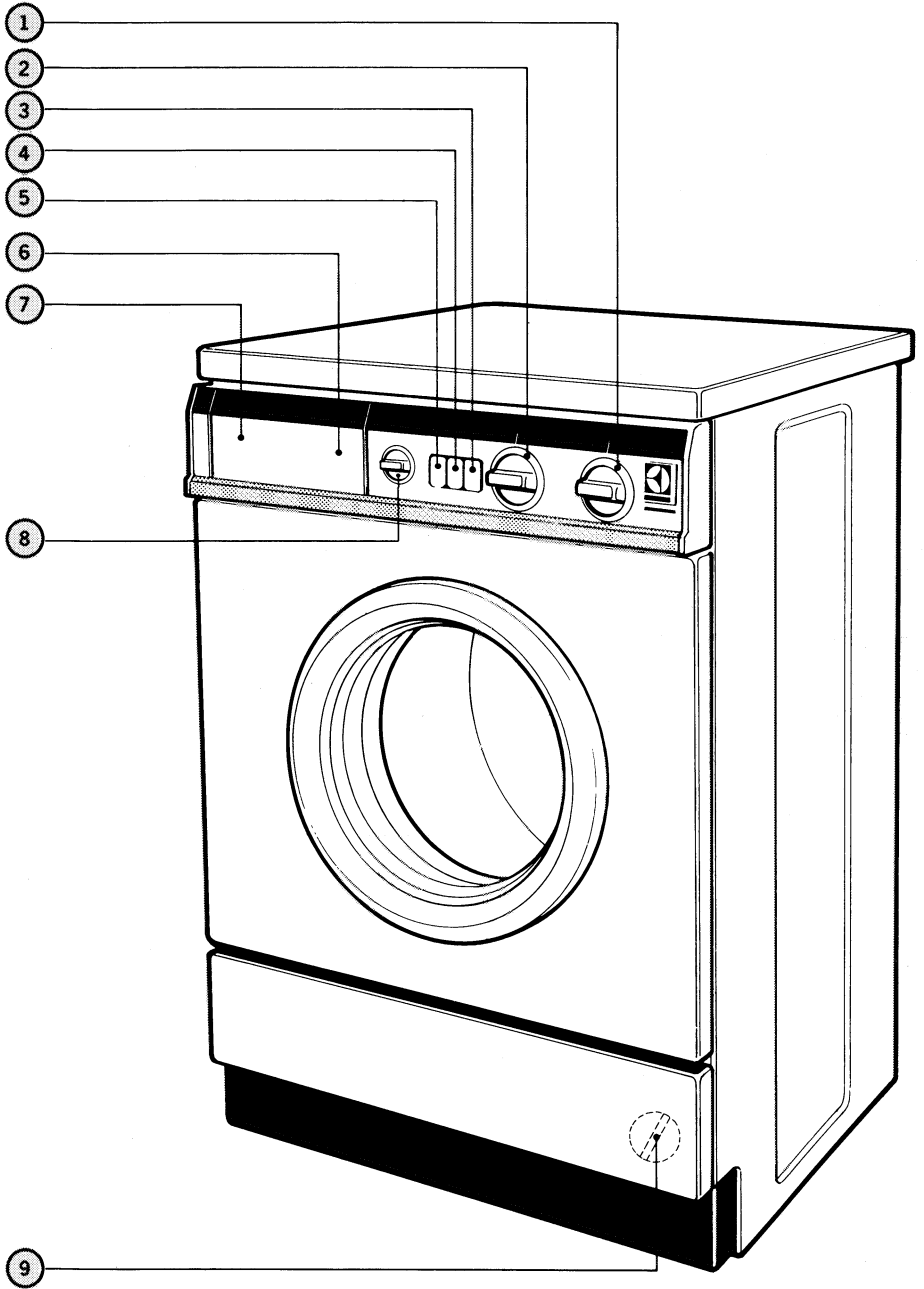

Electrical information

Connecting to the mains

Before you use your washer dryer check that the voltage shown on the data plate conforms with your mains supply.

The mains lead of the washer dryer is fitted with a non-rewireable moulded-on 13 amp plug containing a 13 amp fuse. In the event of the fuse requiring replacement, the fuse cover/carrier should be removed, using a small screw driver to lever it out. The old fuse should be replaced by a 13 amp ASTA approved BS1362 fuse and the fuse cover/carrier must be refitted before the plug is used again.

If the fuse cover/carrier is lost, a replacement can be obtained from the Electrolux Service Shops and offices listed on page 21. The fuse cover/carrier must be of the same colour as that of the coloured insert in the base of the plug.

In no circumstances must the plug be used without a correct fuse cover/carrier fitted.

If the plug supplied on the mains lead is not suitable for the socket outlet in your home it should be cut off and disposed of safely, or destroyed, to avoid any possible shock hazard resulting from the plug being inserted into a 13 amp socket elsewhere in the house. A suitable replacement plug should be fitted (as in Fig. 1). If a 13 amp plug and socket are not used, the circuit supplying the washing machine should contain a 15 amp fuse.

However we recommend that this operation be carried out by a member of the Electrolux Service Organisation or a qualified electrician.

**WARNING —
THIS APPLIANCE MUST BE EARTHED.**

IMPORTANT

The wires in the mains lead of this appliance are coloured in accordance with the following code:—

GREEN-and-YELLOW: EARTH

BLUE : NEUTRAL

BROWN : LIVE

As the colours of the wires in the mains lead may not correspond with the coloured markings identifying the terminals in your plug, proceed as follows:—

Connect the GREEN-and-YELLOW coloured wire to the plug terminal marked letter E or earth symbol \equiv or coloured green or green-and-yellow.

Connect the BROWN coloured wire to the plug terminal marked letter L or coloured red.

Connect the BLUE coloured wire to the plug terminal marked letter N or coloured black.

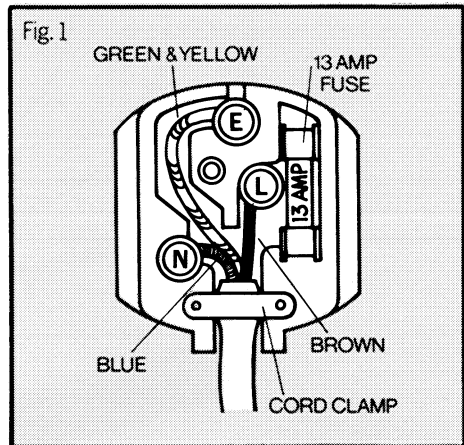

The controls and how to use them

1. Programme Selector dial and on/off control

The selector dial is marked with letters corresponding to those on the programme guide.

To set the machine to the correct programme (see programme guide and table on pages 9-12) press in the central grip to engage the dial and turn clockwise until the letter you want coincides exactly with the pointer. **Never attempt to turn the control dial in an anti-clockwise direction.**

Do not turn the programme selector knob when the machine is in operation. (Indicator Lamp “on”). To start the machine, pull out the central grip. If the central grip does not come out easily check that the pointer is in line with the selected letter – if it is not, reset the dial.

To stop the machine during a wash cycle or drying cycle, push the central grip in.

At the end of a programme the machine will stop automatically. Push the central grip in and the indicator lamp will go out.

2. Drying time control

The drying time can be adjusted up to a total of 180 minutes.

To select the time you require press in the central grip to engage the dial and turn the knob until the time required coincides exactly with the pointer.

3. Door release button

Press this to unlock and open the door. Your washer dryer has a safety lock which prevents the door being opened whilst the machine is in operation. You must wait 1-2 minutes after the end of the programme before you can open the door.

If it is necessary to interrupt a programme to open the door, first switch off the machine by pressing the central grip of the programme dial, then set the programme dial to DRAIN, and switch the machine on again. After draining the programme will advance to an OFF position, and a short time delay will occur before the door can be opened. At the end of the synthetics programme the washing remains suspended in water. Turn programme dial to Spin (W) or Drain (Y) before opening the door.

4. Half load/Autodry button

By pressing this before selecting a wash programme the intake of water is reduced. This is useful if you want to wash half loads, 2.25kg (5lb) instead of the usual 4.5kg (10lb) of cotton or linen items.

By reducing the water consumption you will use less electricity.

The half load programme is not suitable for synthetic or mixed fabrics, delicate articles or wool. These fabrics all need a high water level to avoid creasing.

When using this pushbutton it is possible to programme the machine to run automatically from the wash programme to the drying programme without pausing.

This is because when washing a half load it is not necessary to remove any clothes before drying. To do this: first select the wash programme, then push the half load button, and then select the required drying time using the drying time control.

After completing the washing cycle, the machine will automatically begin the drying cycle.

5. Delicate dry button

When drying items requiring special care, the drying temperature can be reduced by pressing this button when selecting your programme.

6. Detergent Dispenser

To open the dispenser, press the programme guide on the front panel, and pull on the lip of the drawer.

The dispenser has three compartments – (a) for prewash powder (b) for main wash powder and (c) for fabric conditioner (see Figure 2).

The fabric conditioner compartment is fitted with a removable filter to enable it to be easily cleaned.

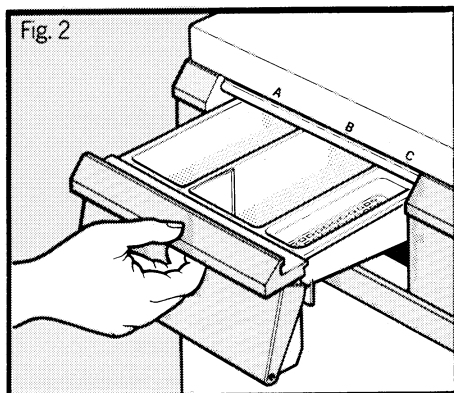

7. Programme Guide

This guide will help you to select the correct wash programme. The letter and wash programme numbers correspond to those used in the detailed charts on pages 9-12.

8. Delay start timer

The delay start timer allows you to delay operation of the machine for anything up to twelve hours and is divided into half hour segments which allows both delayed operation of the machine and also to take advantage of Economy 7 overnight cheap rate electricity.

To use the delay start timer, you should set your machine in the normal way. Set the timer to the number of hours you wish to pass before the wash takes place, for example if you set the machine at 7pm and want it to start at 12pm, you should turn the delay start timer to 5. You should then turn on your machine by pulling out the control grip on the Programme Selector Dial. The machine is then on, but will not start washing until the time you have specified.

9. Pump filter

This is situated at the base of the cabinet. It will need cleaning from time to time (see page 17).

The washing programme





The Washer/Dryer has 21 programmes plus additional economy options (see charts pages 9 to 12). Each washing programme is designed for a specific type of fabric, for example cotton, nylon, mixed fabrics such as polycotton, etc. They follow the International Textile Care Labelling Code (ITCLC) which is used for wash labels on garments and household linen as well as on washing powder packets.

This makes it simple to choose the right programme for the fabric you are washing. The wash cycles for robust fabrics (A-G) are completely automatic, taking the clothes through washing, rinsing, spinning and draining. The wash cycles M-T are for minimum iron, drip dry and delicate fabrics. The machine stops after the last rinse before the water draining and spinning. To complete the cycle, turn the programme selector dial to cycle W for water draining followed by a short spin, or to cycle Y for drain only if you are washing drip dry articles.

Cottons, linens wash cycle and drying

For cotton, linen and viscose (rayon) fabrics

Recommended wash load: 4.5kg (10lb) max

Wash cycle Position of programme selector	Dispenser compartments a b washing powder	c fabric conditioner	Wash cycle description and fabric guide
A Prewash	a		Cottons and linens. Prewash (30 mins.) in water at 30°C (normal level) followed by a soaking phase – the laundry is left soaking in the water. To drain the water, turn the programme knob to cycle W (drain with a gentle spin) or Y (drain only).
B Whites – heavy soil 	a b	c	White cottons and linens without special finishes. Prewash in water at 30°C (normal level). Main wash in water at 95°C (normal level). 4 cold water rinses (high level). Spinning.
C Whites 	b	c	White cottons and linens without special finishes. Main wash at 95°C (normal level). 4 cold water rinses (high level). Spinning.
D Fast Coloureds – heavy soil 	a b	c	Cottons, linens and viscose. Prewash in water at 30°C (normal level). Main wash in water at 60°C (normal level). 4 cold water rinses (high level). Spinning.
F Fast Coloureds 	b	c	Cotton, linens and viscose. Main wash in water at 60°C (normal level). 4 cold water rinses (high level). Spinning.

Cottons, linens wash cycle and drying

Wash cycle Position of programme selector	Dispenser a b washing powder	compartments c fabric conditioner	Wash cycle description and fabric guide
G Non-fast Coloureds 	b	c	Cottons, linens and viscose. Main wash in water at 40°C (normal level). 4 cold water rinses (high level). Spinning.
H Rinses		c	Cottons, linens and viscose. 4 cold water rinses (high level). Spinning.
J Special treatments		c	Cottons, linens and viscose. Intake of water mixed with liquid additive such as fabric conditioner (high level). Special treatments. Spinning.
K* 1000 Spin			Spinning for about 6 minutes with simultaneous water draining. This is preceded by slow rotations of the drum.
L Drying			Reverse action tumble 2 heat settings.





*It is important when selecting this programme that the selector dial is accurately lined up with the programmer letter "K". This is because the spin cycle has to be preceded by a slow drum rotation to enable spin start up.

Water filling
30°/40°/50°C programmes – cold water filling
60°C programmes – hot and cold filling
95°C programmes – hot water filling only.

Delicates and synthetics wash cycle

For delicates, synthetics including acrylics, acetates, triacetates, machine-washable woollens and synthetics mixed with polyester and wool.

Recommended wash load: 1.5-2kg (3-5lb); wool max: 1kg (2lb)

Wash cycle Position of programme selector	Dispenser a b washing powder	compartments c fabric conditioner	Wash cycle description and fabric guide
M Special finish cottons	b	c	Cotton articles with special finishes drip-drying. Main wash in water at 95°C (high level). 3 cold water rinses (high level).
N Whites – heavy soil	a b	c	White nylon and polyester/cotton mixtures. Prewash in water at 30°C (normal level). Main wash in water at 60°C (high level). 3 cold water rinses (high level).
P Whites	b	c	White nylon and polyester/cotton mixtures. Main wash in water at 60°C (high level). 3 cold water rinses (high level).
Q Minimum Iron 	b	c	Coloured synthetics and mixed fabrics. Main wash in water at 50°C (high level). 3 cold water rinses (high level).
R Delicates 	b	c	Acrylics, acetates, triacetates and wool mixtures. Main wash in water at 40°C (high level). 3 cold water rinses (high level).
S Woollens  	b	c	Machine washable woollens and mixtures with cotton or viscose; blankets. Main wash in water at 40°C with a steady drum (high level). 3 cold water rinses (high level).
T Silks	b	c	Silks and printed acetate fabrics. Main wash in water at 30°C (high level). 3 cold water rinses (high level).

Delicates and synthetics wash cycle

Wash cycle Position of programme selector	Dispenser a b washing powder	compartments c fabric conditioner	Wash cycle description and fabric guide
U Rinses		c	3 cold water rinses (high level).
V Special treatments		c	Intake of water mixed with liquid additive (high level).
W 500 Spin			Water draining followed by a short spin at 500 rpm.
Y Drain			Water draining with a steady drum.

Note: There is no water draining after the last rinse of the gentle wash cycles. This prevents the clothes from creasing if they are left in the machine at the end of the wash cycle.

The clothes are held suspended in water until you turn the selector dial to W when the water will be drained and the clothes will be given a gentle spin. Or the selector dial can be turned to Y when the water will drain away without spinning.

Warning: Do not open the machine door until one of the programmes W or Y has been completed. If you do, there will be a flood.

Using your machine

Sorting the wash

Sort the clothes and household linen according to fabric, colour fastness and degree of soiling, following the charts on pages 9-12. Check with the wash care label sewn to the garment or article; this should have a temperature in a wash tub symbol which corresponds with the programme shown on the charts. For example, if your sheets have a label with 95° in the wash tub you can choose either programme B or C depending on whether the articles are lightly or heavily soiled. If the garment has no label, choose the appropriate programme for the fabric. If you are uncertain what fabric this is, always choose one of the gentle wash cycles such as R or S. Be cautious with coloured items unless they are labelled colourfast, wash them separately by hand, or use the programme for non-fast coloureds.

For the best results wash a full load.
4.5kg (10lb) of cottons 1.5-2kg (3-5lb) synthetics
1kg (2lb) machine washable woollens

Until you are familiar with the size of a full load, weigh the articles on the kitchen or bathroom scales. Try to mix large and small items in each load. If you cannot make up a full load of similar items (eg cotton sheets and towels) make up a load of any polycotton and cotton items, and use one of the lower temperature washes Q (50°C). Remember, however, that white cotton and linen should be washed at a higher temperature (95°C) every third wash to keep them a good colour.

The half load programme is also useful, if you cannot make up a full load of cottons and linens.

Loading the clothes

Open the drum loading door by pushing the door release button. Put the sorted articles into the drum one by one, shaking them out first. Alternate large and small items.

Be sure all pockets are empty, buttons and zips fastened. Avoid washing frayed or torn articles, and treat stains such as paint, ink, rust and grass before washing (see page 19). Once the machine is loaded close the door firmly. Then put the washing powder and conditioner (if required) into the dispenser.

Important:

Only laundry washed in water should be dried in the dryer.

In particular, the following fabrics should not be loaded into the dryer:

Clothes which have been dry-cleaned, or cleaned with chemical solvents.

Woollens or mixed woollens which will shrink with heat (check label for suitability).

Extremely delicate fabrics, such as silk and synthetic curtains. Sponge, rubber & similar items.

Fibreglass items.

Paper products (e.g. kitchen cloth).

Choosing the right washing powder

Always use a low lather powder. This is important as too much lather prevents the articles from tumbling freely and being properly cleaned. **New System Persil Automatic** is specially designed to complement the cleaning action of the machine.

Filling with washing powder

The detergent dispenser has three compartments (figure 4). Compartment "a" is for the prewash powder, "b" for the main wash powder, and "c" for fabric conditioner. The same type of wash powder can be used for the pre and main wash cycles. Pull out the dispenser by pressing the spring loaded front and pulling on the lip of the drawer and add the measured amount of powder, following the directions on the wash powder packet (see also Table opposite). Be sure to use enough powder – this is essential to get the clothes really clean. Once the dispenser is filled, close it by pushing it in gently. This is particularly important if you are using a fabric conditioner because if the drawer is slammed it will cause the conditioner to enter the machine prematurely.

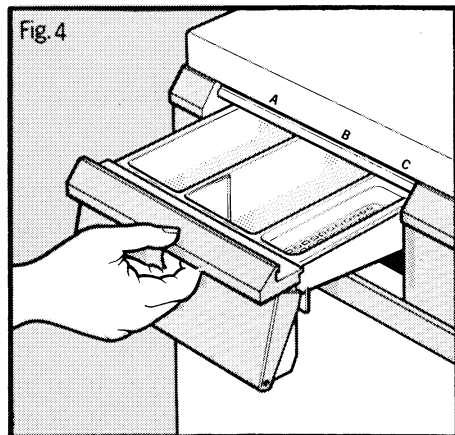

Amount of wash powder in grammes for a full load.

Hardness	Pre-wash	Main wash following pre-wash	Main wash
Soft	20	85	95
Average	60	135	160
Hard	90	185	230
Very hard	125	235	270

For half loads use half quantity.

For information regarding the degrees of hardness of water in your area, ask the local Water Authority.

Using fabric conditioners

When you want to use a conditioner, put the measured amount (follow manufacturers' instructions) into compartment "c" in the washing powder dispenser at the same time as you put in the washing powder. Comfort fabric conditioner is recommended for use as it is designed to complement the cleaning action of the machine. **Be careful not to fill the compartment above the level of the filter.** The conditioner will be automatically used by the machine at the appropriate time. Remember to close the drawer gently (see opposite).

To start the machine

Check that:
the mains switch is on and the machine is plugged in;
the door is properly closed;
the water is turned on.

Select the programme required by pushing in the central grip and turning the programme selector dial clockwise to the required letter. Pull out the central grip. The indicator light will then come on and the machine will start. When

selecting the drying cycle, you also have to set the required drying time by turning the time control. The machine will automatically carry out all the operations up to the end of the chosen programme. Then it will stop.

The ON/OFF indicator will not go out until the central grip is pushed in to switch the machine off.

If, after the start of a programme, you find you have selected the wrong one, push the central grip in to stop the machine. Then turn the dial clockwise to the correct position and pull the grip out to restart the washing cycle.

At the end of the programme push the grip in to switch the machine off.

Unloading the clothes

The drum door remains automatically locked for 1-2 minutes after the machine has been switched off. You can then open the door and unload the machine. **If you have been using a gentle wash cycle do not forget to set the machine to drain the water (programme W or Y) before opening the door.**

Additional programmes

Half-load programme/Auto dry button

Use this for smaller loads of cotton and linen items – 2.25kg (5lb) max. Press in the half-load button, then select the appropriate programme.

Do not, however, use any of the gentle action programmes as these need a higher water level, than is allowed for the half-load programme. See page 7.

Spin only

This programme can be used to remove water from hand washed articles or any laundry which may have got wet but does not need washing. For example, washing left on the line during a rainstorm. See pages 10 and 12.

Special treatments

If you want to treat an article with fabric conditioner without washing it first, you can do this on either programme J or V.

Warning

When the washing machine has finished, always switch off the machine and cancel any selector buttons which may have been used. You should always switch off the power supply at the wall socket, and turn off the stop cocks on the water inlet hoses.

Rotate the drum after removal of the washing, to ensure that small articles have not been overlooked. Finally, wipe the rubber door seal dry.

Drying

Drying cycle

If you wish to machine dry your laundry at the end of a wash cycle, do not turn off the water supply to the machine, ensure that the outlet hose is attached to the standpipe, or hooked over the edge of the sink if not permanently plumbed in.

During the drying cycle the machine requires approximately 0.5 litres (0.9 pints) of water per minute.

Moisture is removed from the spun laundry by means of a special heating element.

This turns to steam in the machine, the cold water supply causes the steam to condense and this drains away together with the cooling water through the drain hose, therefore, there is no need to provide special ventilation in the room where the machine is installed.

To carry out a drying cycle:

1. **Important:** Load only up to a maximum of 2.25kg (5lb) of spun laundry into the drum. Take care to load machine loosely. In the case of easy care (non-iron) clothes, load only up to a maximum of 1kg (2.2lb).
2. Close the loading door.
3. Set the drying time control as required.
4. Turn the programme control to "L" and pull out the control knob.

The indicator light will come on and the drying cycle starts.

The duration of the preset drying cycle may be shortened or extended during the drying cycle.

This should not be done however, in the final 10 minute cool down period because during this time both the machine and the laundry must be allowed to cool off.

If there is a power failure or some other interruption during the drying cycle, the laundry should be removed from the machine without

delay. This is because whilst the drum is inoperative there could be a heat build-up which may damage the more delicate fabrics being dried. If you want to interrupt the drying cycle, push in the programme control knob. Wait for 1-2 minutes before trying to open the door to allow the door safety interlock to release.

Auto dry

It is possible, when using the "Half-Load" button (i.e. washing a half-load) to programme the machine to run automatically from the wash programme through to the drying programme without pausing. Leave the water supply to the machine switched on and the drain hose attached to the standpipe or hooked over the edge of the sink.

Proceed as follows:

1. Load the machine.
2. Select wash programme required, using programme selector (1).
3. Push the "Half load" pushbutton (4).
4. Select the required drying time, using drying time control (2). After spinning, the machine will automatically begin the drying cycle.

Drying times for fabrics

The drying times of all fabrics and clothes will depend on the extent to which they have been spun as well as their distinctive characteristics. The times given are a general indication only of the average drying times. Each user will soon work out more specific times from personal experience of the machine.

Load	Iron-dry	Store-dry
2.25kg (5lb) normal laundry	110-130 minutes	155-175 minutes
1kg (2.2lb) easy-care clothes		60-80 minutes

To prevent creasing, all clothes should be removed from the drum as quickly as possible after completion of a drying cycle.

Looking after your machine

Important: Make sure that the machine is unplugged and the water taps turned off before undertaking any kind of maintenance.

General care and cleaning

After each wash leave the door ajar for about two hours, to allow air to circulate freely inside the drum.

Wipe round the rubber door seal to remove the water which collects in it.

From time to time clean plated, polished and plastic parts and the glass porthole door with a soft damp cloth. Never use abrasive powders. Wipe over the exterior cabinet with a lukewarm solution of a mild liquid cleaner, rinse and dry thoroughly. From time to time, apply a little wax furniture cream with a soft cloth.

If the washer has been out of use for a long time, carry out a complete cycle (G) without washing a load, adding 25g (1oz) Calgon water softener to the detergent dispenser instead of wash powder.

Pump filter

Your Electrolux washing machine is fitted with a special filter designed to trap fluff, lint and any other small objects inadvertently left in the washload, so protecting the discharge pump.

This filter is located behind the bottom front panel, and should be cleaned from time to time. To get at the filter, the panel is removed by gripping it at both sides and pulling it towards you. It can then be used to catch any residual water that emerges when the filter is removed.

To remove the filter, unscrew it in an anti-clockwise direction (figure 5), pull out the small extractable gutter under the filter cover, and withdraw the filter from its tube (figure 6).

Remove any objects or fluff, rinse the filter under a tap, and replace in the machine.

Cleaning inlet filters

These are situated at the back of the machine and should be inspected from time to time.

Unscrew the hoses and remove the mesh filter lodged just inside the hose. Run them under a fast running tap to remove any sediment.

Replace the wire filters and the hoses firmly.

Cleaning the washing powder dispenser

Wipe it out after every wash.

From time to time it will need more thorough cleaning to clear out all the deposit. Remove the drawer completely with a sharp pull outwards.

When you replace it, if you find that it doesn't slide right in again give it a sharp tap with the palm of your hand.

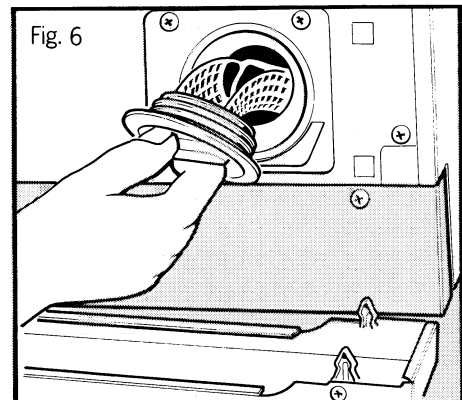
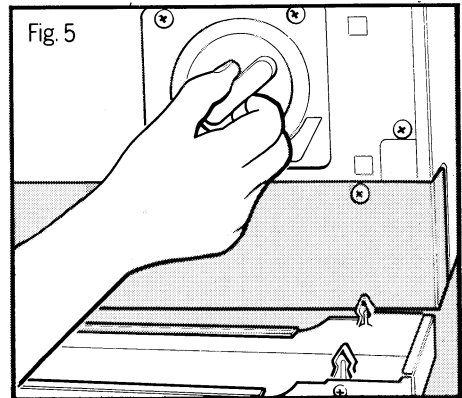

Helpful tips for successful washing

Here are some practical hints to help you get the best washing results.

Don't overload the machine. The clothes will not move round freely if there are too many of them and the washing powder may not dissolve properly.

Always use a low suds washing powder specially made for front loading machines. Excessive foaming gives an unsatisfactory wash and may even harm the machine. The quantity of washing powder required depends on the amount of laundry and how soiled it is. It may therefore be necessary to vary the quantities suggested on page 14. You will be able to tell if you need to do this when you are used to the machine.

Don't put washing powder into the dispenser until just before starting a programme. If the powder is left for any length of time in the dispenser it may form lumps which are difficult to dissolve.

For best results do not wash more than 1kg (2lb) of woollen articles at a time.

Wash only woollen articles marked "machine washable".

For best results do not wash more than 1.5-2kg (3.5lb) of synthetic fabrics in one load. Synthetic fabrics need plenty of room to move around or they tend to crease.

Clothes should be sorted according to the fabric – colour fastness and degree of soiling (see page 13).

Mend open seams and tears before washing.

Close zips, secure buttons.

Collect laces, washable belts etc and put them in a bag for washing.

Empty pockets. **(This is important as should a coin become lodged between the tub and drum it can cause extensive damage). See final note on page 20.**

Remove spots of rust, paint, ink and grass stains before washing (see instructions page 19.)

Don't wash light coloured fabrics with dark ones.

One may leave specks of fluff on the other.

Don't risk washing coloured articles unless you are sure they are colourfast. It's worth hand washing the article to find out.

If you live in a hard water district, you can add Calgon water softening powder to the washing machine in compartment "b". For the quantity of Calgon to use, see packet directions.

Nappies

Leave the soiled nappies soaking in a solution of proprietary nappy cleaner. When there are sufficient for a wash, drain off the water and rinse by hand in cold water (this is advisable as some nappy cleansers have an adverse effect on the rubber door seal), then transfer the nappies to the washing machine. Set the selector dial to K (fast spin) to remove the excess solution. Then wash the nappies on programme C (whites). Dry and air them thoroughly.

Blankets

Only wash blankets which are labelled as suitable for machine washing. Use wash programme S (woollens) followed by programme W (drain and spin) which will remove the excess water and leave the blanket ready to tumble dry or hang out on a line.

Curtains

Check that the fabric is washable. Remove all the curtain hooks and if the heading is drawn up by means of curtain tape, release the strings to allow the fabric to spread flat. Weigh the curtains and decide if you can wash them in one or more loads. Select the correct programme for the fabric. If the curtains have not been washed for

some time they may be dusty, in which case it is a good idea to rinse them on programme H or U according to the fabric. After draining, start the suitable wash programme.

Dyeing

You can dye fabrics successfully in the machine but it is essential to buy a good proprietary dye and to read the manufacturer's instructions carefully. Make sure that the fabric is suitable. The dye instructions will guide you on this point. Then wash the article to make sure it is thoroughly clean, using programme C or Q according to the fabric. Then follow the instructions for machine dyeing, supplied with the dye.

Immediately after you have removed the dyed material from the machine, set it to programme G (without adding washing powder to the dispenser) to clean all traces of dye from the machine.

Stain removal

Some stains will not be removed in the wash. It is wise to treat them before laundering.

The following are simple but effective treatments to use on any washable fabric. Treat the stain as soon as possible and launder afterwards to remove any residual stain.

Ballpoint and felt-tip ink:

Dab with methylated spirit on cotton wool (not on acetate or triacetate fabric).

Fountain pen ink:

Sponge with cold water to flush out as much ink as possible, or hold the fabric under running cold water. Launder and treat any remaining stains with lemon juice.

Grass stains:

Dab with white spirit (not on acetate or triacetate). Rinse in clear water.

Oil:

If heavy stains from cycle or car oil do not come out in the wash, treat them with a proprietary grease solvent.

Paint: Emulsion:

Sponge immediately with cold water and then launder. If the stain has dried, soften it with white spirit or a proprietary paint brush cleaner. (Test an inconspicuous corner of the fabric first).

Gloss:

Dab with white spirit or proprietary paint brush cleaner. (Test fabric first).

Rust (iron mould):

Rub with lemon juice and then sprinkle salt over the stain and leave for an hour. If subsequent washing does not remove the stain, use a proprietary rust cleaner following manufacturer's directions.

Warning:

Do not attempt to repair the machine yourself.

Repairs carried out by unauthorised or inexperienced persons might cause injury or more serious malfunctioning.

Servicing

If, having followed these instructions carefully, your machine fails to work properly contact your local Electrolux service office. Before you do that, though, it is worth making a few simple checks yourself.

If the machine won't start . . .

Ensure that the programme control knob on the machine is pulled out into the "on" position. For the drying cycle make sure that the required time has been selected by means of the drying selector dial.

Check delay start timer has not been moved and is at '0'.

Make sure that the door of the machine is firmly shut.

Make sure that the appliance is properly plugged in and that the socket switch (if any) is in the "on" position.

Check that there is power at the socket by plugging in an appliance you know to be working – a small lamp, for example. If this too fails to work, check the main circuit fuses in your home's consumer unit or main fuse box.

If the machine won't fill . . .

Make sure the supply hoses are not sharply bent. Make sure taps and stop-cocks are turned on. Check that there is sufficient water pressure.

If the machine won't drain or spin . . .

Check that the drain hose is not bent, blocked, or obstructed in some other way, and also check the filter for fluff, etc.

If the machine empties as it fills . . .

Make sure the end of the drain hose is not less than 50cm (20in) above floor level.

If the machine vibrates badly, or is too noisy

Check that the machine is absolutely level. Check that there is sufficient clearance between the machine and nearby wall, furniture, etc. Check that all the internal packing, plastic spacers and transit security bolts have been removed as described in the installation instructions.

Failure to observe these checks could result in your being charged for the service call when requested.

Cautionary Notes

1) It is very important to follow carefully each garment manufacturers washing and drying instructions.

2) Woollen garments and those manufactured from synthetic/wool mixtures should always be dried to the garment manufacturers instructions which usually state that they should be gently pulled into shape and dried on a flat surface.

3) Never put dripping wet clothes into the dryer.

4) Children have been known to climb into unattended tumble dryers when not in use.

Always remove the plug or switch off at the socket outlet.

5) Never put clothes into the dryer which are contaminated with flammable liquids, such as petrol and cleaning fluids, or hair lacquers, creams, cooking fat, oils, wax or paint. This is important because even small remaining traces of these substances can cause fires under certain circumstances.

For the same reason you should not tumble dry articles containing foam rubber or rubber-like materials, plastic or plastic foam, nappy pants or polythene bags.

Electrolux Service Organisation

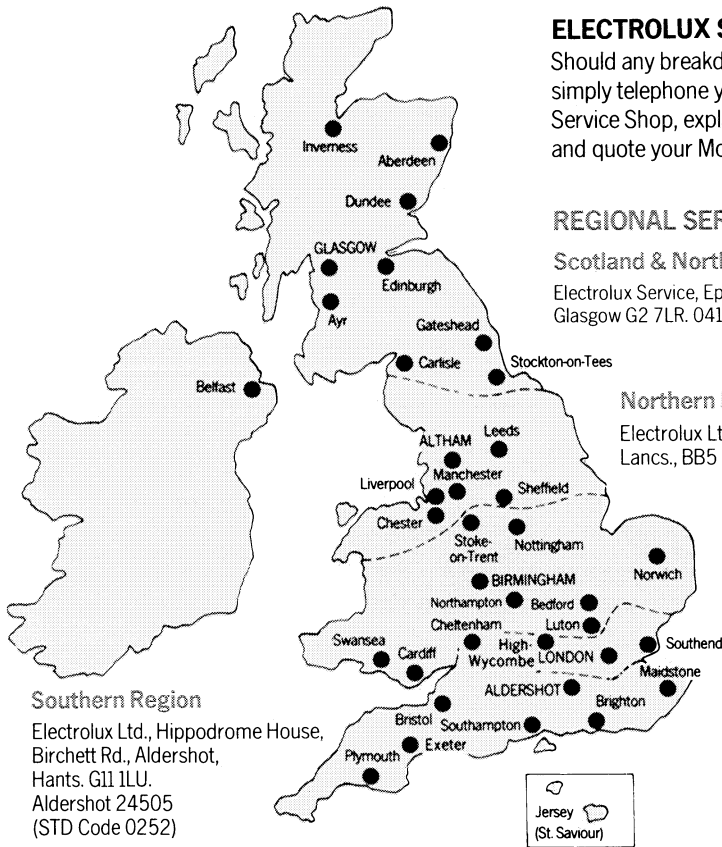

ELECTROLUX SERVICE OFFICES

Should any breakdown occur with your appliance simply telephone your nearest Service Office or Service Shop, explain the nature of your problem and quote your Model number.

REGIONAL SERVICE OFFICES

Scotland & North Eastern Region

Electrolux Service, Epic House, 28-32 Cadogan Street, Glasgow G2 7LR. 041-204 0411

Northern Region (inc. N. Ireland)

Electrolux Ltd., Altham Lane, Altham, Accrington, Lancs., BB5 5XY. Padiham 74621 (STD Code 0282)

Midlands & South Wales Region

Electrolux Ltd., 3 Strensham Hill, Moseley, Birmingham B13 8AQ. 021-449 5252

London Region

Electrolux Ltd., 842 Coronation Road, Park Royal, London NW10 7QA. 01-965 9699

Southern Region

Electrolux Ltd., Hippodrome House, Birchett Rd., Aldershot, Hants. GU11 1LU. Aldershot 24505 (STD Code 0252)

ELECTROLUX SERVICE SHOPS

Aberdeen 695761 (STD Code 0224)
 Ayr 262242 (STD Code 0292)
 Bedford 219000 (STD Code 0234)
 Belfast 740 296/7 (STD Code 0232)
 Brighton 694341 (STD Code 0273)
 Bristol 211876 (STD Code 0272)
 Cardiff 387444 (STD Code 0222)
 Carlisle 44568 (STD Code 0228)
 Cheltenham 584051 (STD Code 0242)
 Chester 312038 (STD Code 0244)
 Dundee 22630 (STD Code 0382)
 Edinburgh 031-229 1232
 Exeter & E. Devon 217138 (STD Code 0392)
 Gateshead 4600440 (STD Code 091)
 High Wycombe 41042 (STD Code 0494)
 Inverness 223056 (STD Code 0463)

Jersey (St. Saviour) Central 22138 (STD Code 0534)

Leeds 608511 (STD Code 0532)
 Liverpool 051-220 8014
 Luton 575966 (STD Code 0582)
 Maidstone 677727 (STD Code 0622)
 Manchester 061-798 9689
 Northampton 69222 (STD Code 0604)
 Norwich 667017 (STD Code 0603)
 Nottingham 396927 (STD Code 0602)
 Plymouth 58161 (STD Code 0752)
 Sheffield 338674 (STD Code 0742)
 Southampton 785231 (STD Code 0703)
 Southend 354313 (STD Code 0702)
 Stockton-on-Tees 674848 (STD Code 0642)
 Stoke-on-Trent 413414 (STD Code 0782)
 Swansea 51848 (STD Code 0792)

Guarantee

This Guarantee is offered to you as an extra benefit and does not affect your legal rights.

Electrolux products are carefully designed, manufactured, tested and inspected and in consequence we undertake to replace or repair any part found to be defective in material or workmanship, within one year of delivery to the original purchaser, free of charge.

ADDITIONALLY, DURING THE SUBSEQUENT FOUR YEARS, ANY DEFECTIVE PARTS WILL BE REPLACED FREE – LABOUR COSTS ONLY BEING CHARGEABLE, provided that within 14 days of the purchase the Guarantee Registration card is completed and returned to the Company.

This Guarantee is conditional upon service being carried out by an Electrolux Service representative or an authorised agent, and the appliance having been correctly installed and used in accordance with the Company's instructions under normal domestic conditions within the United Kingdom or the Republic of Ireland. It may be invalidated by unauthorised repair or modification of the appliance.

The Company does not accept liability for defects arising from neglect, misuse, or accident.

Proof of the date of purchase will be required before service under guarantee is provided. Addresses or telephone numbers for service requests are listed opposite.

WASHER DRYER WD1039-A LUX MODEL, MADE IN ITALY

These appliances conform with the requirements of
EEC Directive No. 82/499 relating to radio interference.

 **Electrolux**®

ELECTROLUX LTD., LUTON, BEDS. LU4 9QQ

In accordance with its policy of progressive product design
the Company reserves the right to alter specifications.

T501

©Electrolux Ltd., 11/87 Issue 1

Publication No. 8220032

Printed in England.